

## FICHA TÉCNICA

**TL-5408.A27**  
**TL-5408.A41**

DISEÑA tu  
ambiente  
**illux®**

### DESCRIPCIÓN DEL PRODUCTO

Luminario de empotrar para uso exterior, fabricado en aluminio y cristal templado con media pestaña, 1.1W, 110-277V.

### APLICACIONES

Ideal para iluminación de fachadas, pasillos, patios, corredores, jardines y techos.

### DRIVER (INCLUIDO)

Driver a 110-277V~ para operar lámpara SMD LED 1.1W.

Frecuencia nominal: 60Hz

Corriente nominal: 0.45A

### LÁMPARA

Lámpara LED SMD, tiene bajo consumo de energía su mantenimiento es casi nulo y con una vida aproximada de 30,000 horas y temperatura de color 3000°K y 4100°K



### ACCESORIOS (NO INCLUIDOS)

Housing de aluminio  
**H-5408**



### OBSERVACIONES

**TL-5408.A27**



**TL-5408.A41**



EXTERIOR

EMPOTRAR







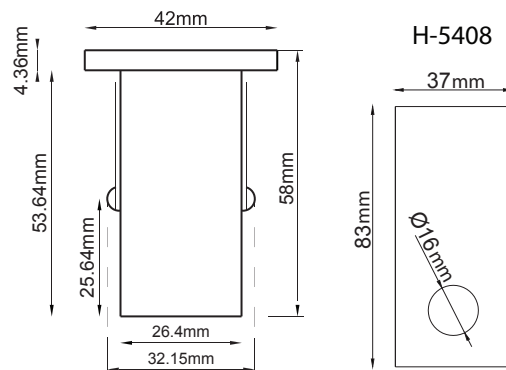





### PRODUCTO

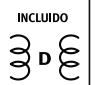

### DIAGRAMA



### SIMBOLOGÍA

 32mm	 SMD LED	 <b>MAX</b> 1.1 <b>W</b>	 110-277V	 INCLUIDO	 100 LUMENS
 MATERIAL ALUMINIO	 ACABADO ALUMINIO	 IP 65	 30	 IRC ≥85	 30,000 hrs

ILLUX DE MÉXICO, S.A. DE C.V.

Temazcal 21-B, Col. La Loma, Tlalnepantla de Baz, Estado de México, C.P. 54060 Tel. (01)55 5355 9797

[www.illux.com.mx](http://www.illux.com.mx)